

Gillette®

powered by

BRAUN

Series 3



390cc
350cc

型号 5772
型号 5774



2

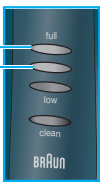
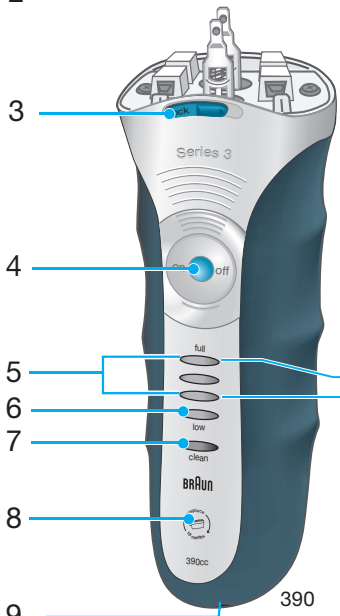

350



10

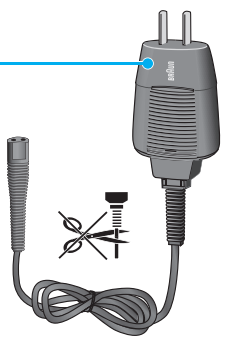

11



12



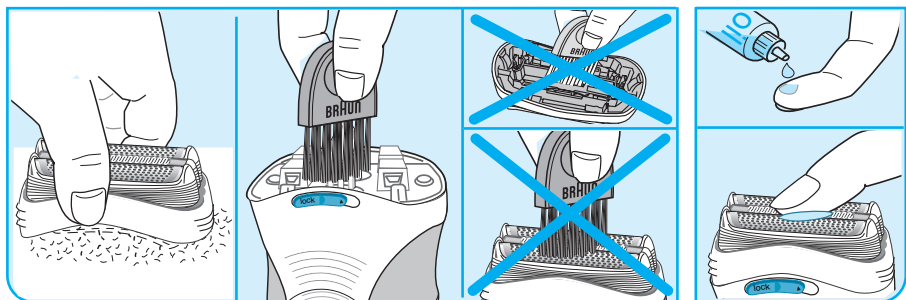
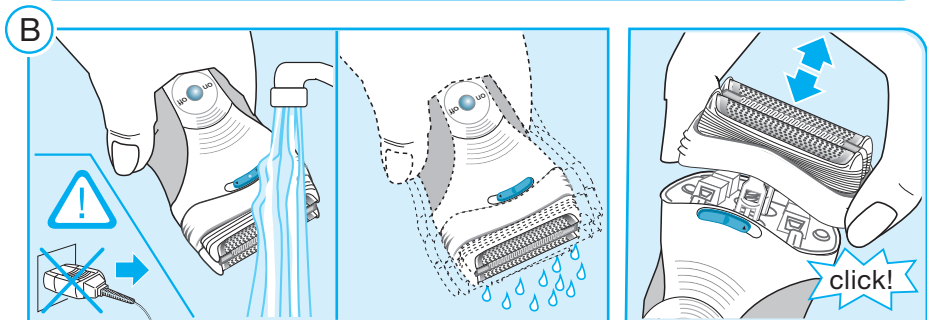
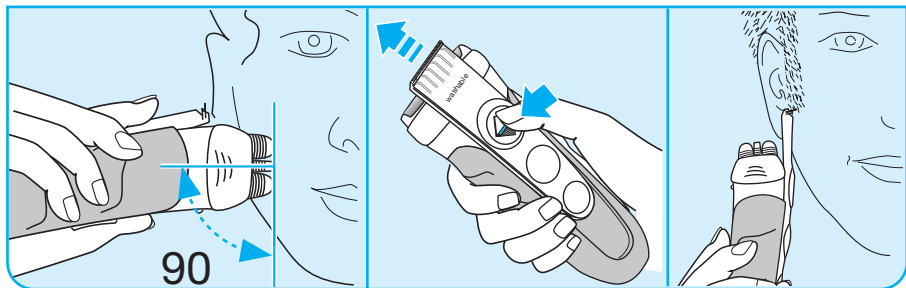
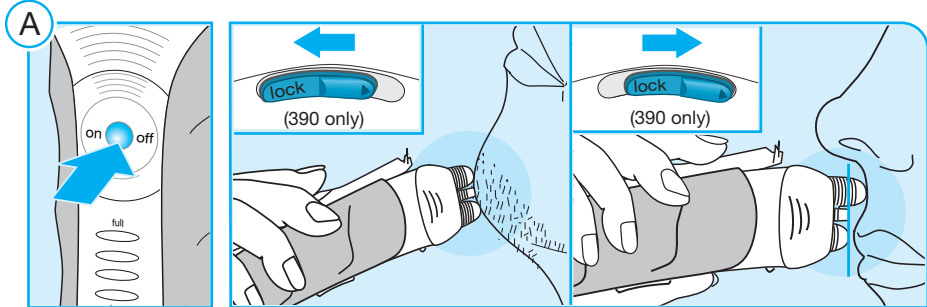

C

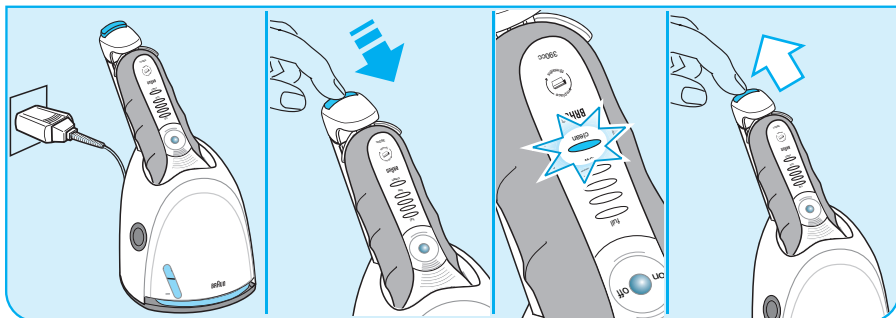
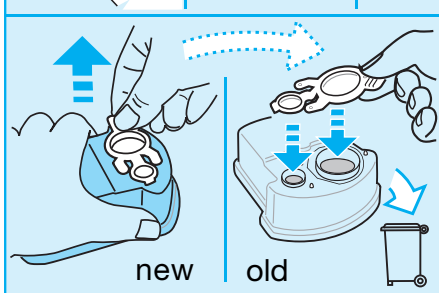
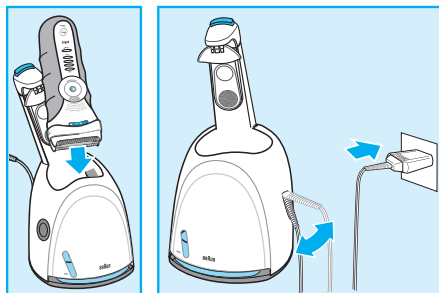
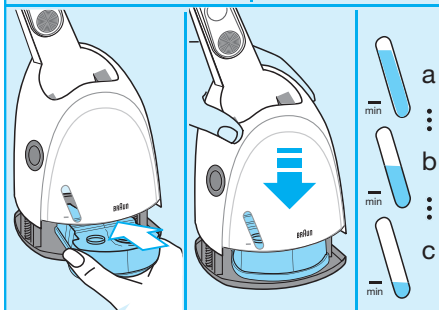
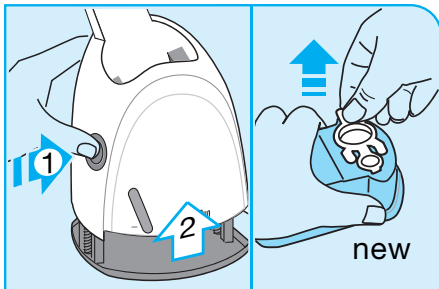
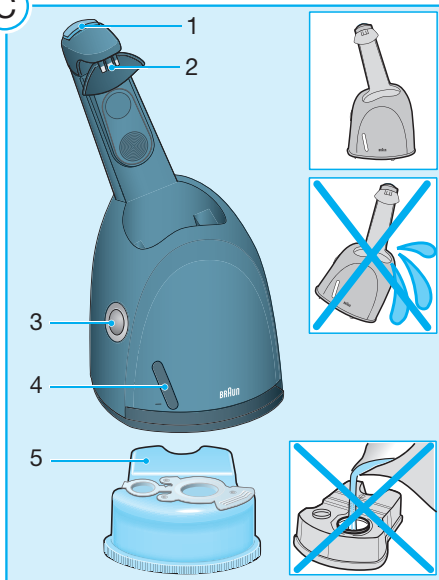

中文

本产品设计优异、功能完善、质量可靠、满足高标准要求。希望您在这款博朗剃须刀感到满意。

使用本产品前，请仔细阅读本使用说明。

注意

本剃须刀提供的专用电源线带有特别的安全低电压转换器。请勿更换或改装转换器的任何部件，否则可能有触电危险。

在无监护人看管的情况下，儿童、行动不便或智力障碍的人不宜使用本产品，一般建议本产品应放置在儿童不能触及的地方。应监督儿童并确保他们不会把本产品当作玩具。

为确保卫生，请勿与他人共用本产品。

如需用于身体其它部位，该处皮肤应平整光滑，请勿用于皮肤破损处。

组件说明

- 1 网膜刀头架
- 2 长须修剪器
- 3 精确设置开关 («lock»)(«锁»)
- 4 On/Off电源开关 (启动/停止)
- 5 充电指示灯 (绿色)
- 6 低电量指示灯 (红色)
- 7 清洁指示灯 (黄色)
- 8 更换零件指示灯
限390cc
- 9 电源插孔
- 10 专用电源线
- 11 旅行包 限390cc
- 12 刀片保护盖
限350cc

充电

充电时理想环境温度为15°C至35°C。请勿将剃须刀长时间置于50°C以上的环境中。

- 关闭剃须刀，用专用电源线 (10) 将剃须刀接通电源。
- 首次充电应持续4小时，此后每次充电约需1小时。

- 电源充满后不接电源可使用长达45分钟，使用时间视胡须浓密程度而定。
- 无线剃须。正常使用时，Clean&Renew™ 清洁/充电系统 每次清洁完即自动开始充电 (详见 C.清洁座说明)。
- 电池的最大容量须经过若干次充电/放电循环后方可达到。
- 5分钟快速充电足够实现一次有效剃须 (使用专用电源线 (10))。
- 充电电池耗尽时可通过专用电源线接通电源剃须。

充电指示灯 (5)

绿色充电指示灯显示电池的充电状态。剃须刀充电或开启时，绿色充电指示灯闪亮。若剃须刀开启或与电源连接，电池充满电后，全部绿色充电指示灯将持续发光。

低电量指示灯 (6)

当电量不足时，红色低电量指示灯将闪烁。您应尽快结束当次剃须过程。

剃须

按压启动开关 (4) 操作剃须刀。(图)

灵活的网膜将顺着您的面部轮廓自动调整。(图)

长须修剪器 (2)

向上滑动长须修剪器 (2) 可修剪鬓角、小胡子、络腮胡。

精确设置开关 («lock»)(«锁») (3)

如须仔细修剪不易剃的部位 (如鼻子下)，将开关 (3) 向右滑动至 («lock»)(«锁») 位置。中间修剪器和一个网膜将缩回。

完美剃须的秘诀

为确保理想剃须效果，博朗特推荐剃须三步骤：

1. 洗脸之前剃须。
2. 剃须刀尽量与肌肤垂直(90°)。
3. 拉伸脸部肌肤，逆着胡须生长方向剃刮。

B 保养剃须刀理想状态

清洁指示器

剃须刀应放在Clean&Renew™清洁/充电系统中每天清洁一次，这个操作应在剃须后黄色的清洁指示灯(7)持续发光时进行。如果不进行清洁，黄色指示灯不久会熄灭。剃须刀的电子芯片将默认为它已手动清洁，下次清洁时将重新计时。Clean&Renew™清洁/充电系统清洁过程中，黄灯闪烁，并于大约4小时后即清洁完成时熄灭。

自动清洁

将剃须刀放入Clean&Renew™清洁/充电系统清洁程序即自动开启(详见C.清洁座说明)。不建议手动清洁，除非当无法使用Clean&Renew™清洁/充电系统时(如旅行时)。



本机刀头可以直接用自来水冲洗。
注意：用水清洗前，应将剃须刀与电源分离。

定期清洁可保证更好的剃须效果。每次剃须后用流动温水冲洗刀头，是保持清洁的便捷方法：

- 启动剃须刀(脱/断线工作)，用流动温水清洁刀头，或用不含颗粒或研磨物质的天然香皂清洗。冲去所有泡沫后保持剃须刀运转几秒钟。
- 关闭剃须刀，卸下网膜刀头架(1)，将其晾干。

- 如果您用水定期清洗剃须刀，请每周在长须修剪器(2)和网膜刀头架上滴加少许轻机油。(图)

可使用配置的小毛刷清洁剃须刀：

- 关闭剃须刀。卸下网膜刀头架，在平坦表面轻轻敲击清除须渣。
- 用毛刷清洁轮廓贴合刀头内部区域，但不要使用毛刷清洁网膜，以免损坏。(图)

更换网膜刀头架/复位

为保持理想剃须效果，在更换零件指示灯(8)发亮(约在18个月后)或零件发生磨损时，应当更换网膜刀头架(1)。

更换指示灯会连续7次在剃须时提醒更换零件，然后自动恢复原显示。更换网膜刀头架后，用圆珠笔按压复位按钮(4)至少5秒钟，复位计数器。

操作时更换提示灯闪烁，完成后熄灭。手动复位可随时进行。

电池保养

为了保持充电电池的理想容量，剃须刀应该约每6个月完全放电一次(通过正常剃须放电)，然后完全充满。

环保提示

本产品内含充电电池。为保护环境，请勿在达到使用寿命后与普通生活垃圾一起丢弃。请在国内专设的适当的收集点处置，或交给博朗售后服务中心统一回收处置。



C Clean&Renew™ 清洁/充电系统

博朗Clean&Renew™ 清洁/充电系统用于剃须刀的清洁、充电和存放。请使用Clean&Renew™ 清洁/充电系统底座每日清洁一次剃须刀。自动清洁过程中,剃须刀会被启动和关闭多次,以获得理想清洁效果。配方独特的清洁液中含有少量机油,因此清洁过程也同时补充剃须刀所需的润滑油。

重要提示:

- 请使用剃须刀的专用电源线。
- 为了避免清洁液泄漏,请将清洁座放在水平稳定的表面上。安装清洁剂盒后,切勿以任何方式突然倾斜、移动或运输该设备。
- 请勿将该设备放置在镜柜中、暖气片上、抛光或涂漆表面上。切勿使其受到阳光直射。
- 该设备含有高度易燃液体。请使其远离火源。切勿接触烟火。
- 请将剃须刀放置在儿童无法接近的地方。清洁剂盒只做一次性使用。仅使用博朗原装清洁剂替用盒。

组件说明

- 1 启动/松懈按钮
- 2 清洁座/剃须刀接口
- 3 更换清洁剂盒提升按钮
- 4 液位指示器
- 5 清洁剂盒

使用Clean&Renew™ 清洁/充电系统

安装清洁剂盒

- 按压提升按钮(3),升起清洁剂盒套。
- 将清洁剂盒放在水平、稳定的表面(如桌面)上。小心取掉密封盖后,将其尽可能地推入清洁剂盒舱。
- 缓慢推回清洁剂盒套至锁紧。

更换清洁剂盒

按下提升按钮(3)打开外罩,稍等片刻后取拿出用过的清洁剂盒,避免滴洒。

由于用过的清洁剂已被污染,丢弃用完的清洁剂盒之前,请确保将其开口用新清洁剂盒的密封盖扣住。

可将用完的清洁剂盒丢弃在生活垃圾中。

操作 Clean&Renew™ 清洁/充电系统

- 将Clean&Renew™ 清洁/充电系统用电源线连接至电源。后面的专用插头是可调节的,可以节约空间。每次剃须后,关闭剃须刀,并将其置于Clean&Renew™ 清洁/充电系统中,颠倒放置,正面向前。
- 按下启动/松懈按钮(1)即锁紧剃须刀并启动清洁程序。整个清洁过程中,剃须刀的黄灯将闪烁(约2分钟清洁,4小时干燥)。
- 请勿中断清洁过程,因为清洁时会弄湿剃须刀,不宜使用。如果必须中断,请按启动/松懈按钮(1)。
- 清洁完成后,黄灯会熄灭,按下启动/松懈按钮将其取下即可使用。
- 一个清洁盒可以清洗30次。当液位指示器(4)降至«min»标记时,剩余的清洁剂还可清洁约5次。若每天清洗,应该约4周更换一次清洁盒。
- 清洁剂中含有酒精,一旦开启即会慢慢挥发。如非每日使用,应当大约每8周更换一次。
- 清洁剂中也含有润滑成分,因此清洁过后可能有润滑成分残留在刀头上。不过,用布或软面巾纸轻轻擦拭即可轻易地去除这些残留。
- 注意经常用湿布清洁清洁座,特别是剃须刀插入口。

附件

经销商或博朗售后服务中心可以提供以下部件：

- 网膜和刀头：32S/32B
- Clean&Renew™清洁剂盒：CCR

本说明可能在不作事先通知的情况下作出修改。

本产品符合欧洲EMC指令2004/108/EC以及低压标准2006/95/EC。



电气规格详见专用电源线标示。

在产品使用寿命后，请勿与普通生活垃圾一起丢弃。请在国内专设的适当收集点处置，或交给博朗售后服务中心统一回收处置。



博朗电动剃须刀

原产地：上海

生产商：博朗(上海)有限公司

地址：上海市闵行开发区绿春路475-495号

邮编：200245

经销商：吉列(上海)产品服务有限公司

地址：上海市浦东新区三林路550号一号楼五层

邮编：200124

Braun是德国博朗公司(Braun GmbH)的注册商标。

执行标准：GB 4706.1/GB 4706.9

经德国博朗授权制造

保修

- 我们为产品提供为期两年的保修，保修期从购买日开始计算。
- 在保修期内对于产品因材料或生产过程引起的各种瑕疵，我们会视情况更换零件或整个产品。
- 申请保修必须将本产品 and 能够证明购买日期的证据(购货发票)一起交给授权的Braun维修站，本产品附有一张授权的维修站名单。
- 请确认已将购货发票放置在安全的地方。

上述保修不包括以下内容：

- ▼ 由于使用不当而造成的产品损坏(如:使用错误的电流、电压，将产品插入不合适的插座，或者人为损坏等)。
- ▼ 剃须刀网膜和刀头的损坏或破烂。
- ▼ 正常使用引起的产品老化、磨损、但对产品的使用功能及价值影响不大。
- ▼ 如果产品经过未经授权的人员的修理，或产品使用了非本公司(Braun)的零件，保修期即终止。
- ▼ 非家庭使用(如工业、商业用)引起的损坏。
- ▼ 本保修适用于全球范围的所有经博朗公司及其指定供应商出售的博朗产品。并且在当地没有进口限制或其它法律条文限制本保修即可执行。
- ▼ 在保修期内提供的服务并不影响保修期的结束，保修期中替换的零件或整机的保修服务于本产品的保修期同时终止。
- ▼ 除非确有法律规定，本公司不对其它任何要求负责。同供货商的销售合同中规定的各项权利不受此保修的影响。

如果需要保修或维修，请与当地或就近的维修站联系。

顾客免费热线：800-8201357

最新Braun售后服务部地址

城市	公司名称	地址	联系电话
中区			
200085	上海 安帮北站天路家用电器维修服务社	上海市永兴路540号(靠近西藏北路)	63566755/56329466
200235	上海 乐帮新尊办公设备维修服务社	上海市漕溪路190号(靠近田林东路)	64688241
201100	上海 上海市闵行区博杰家用电器维修部	上海市闵行区莘建东路210号(莘庄地铁站-北广场)	64122533
310016	杭州 杭州中侨家电维修服务有限公司	杭州市采荷路10号	86047438
215004	苏州 苏州家用电器维修服务中心有限公司	苏州市干将西路1168号	68662852
266071	青岛 青岛市市南区超维影视通讯技术服务部	青岛市市南区银川西路3号政泰商务楼202室	85977910
361003	厦门 厦门市思明区新鹭声电子技术服务部	厦门后埭溪路248号之6、7、8号	5170118
210003	南京 南京博伊华电子电器经营部	南京市中山北路223号建达大厦	83420092
214031	无锡 无锡新讯通信设备服务有限公司	无锡市五爱北路27号	82729805
213001	常州 常州市金博家电经营部	常州市天宁区迎宾路江南佳园4-S-10	88836628
226001	南通 南通市崇川雷声电器服务中心	南通市虹桥路怡安苑11幢04店面	96889688/85102088
315040	宁波 宁波市江东明楼甬城家电维修部	宁波市江东惊驾路506号	87771344
315000	宁波 宁波海曙创佳数码家电维修部	宁波市苗圃路39弄50号(海关对面)	87134422
250013	济南 济南市天桥区启航家电维修部	济南市历下区历山路57号历山商务中心407室	86950100
230022	合肥 合肥国升数码技术服务部	合肥市金寨路93号鸿基国际广场529室	2655887/2654456
450000	郑州 郑州百川电器技术有限公司	郑州市北下街79号	66964036
北区			
100078	北京 北京盛侨家用电器维修服务中心	北京市丰台区方庄芳群园2区6号楼金芳公寓408室	67698025/67630617
100035	北京 北京盛侨家用电器维修服务中心	北京市西城区德胜门内大街54号	66561976
050021	石家庄 河北省家电维修中心	石家庄市槐北路70号	86011793
300022	天津 天津市大东电器维修有限公司	天津市和平区滨江道109号	27120167
300100	天津 天津市大东电器维修有限公司	天津市南开区三马路126号	27120168 / 27120170
110011	沈阳 沈阳市今东业家电技术服务有限公司	沈阳市沈河区承德路36-1	24870309 / 24855340
150010	哈尔滨 哈尔滨市道里区信誉进口家电维修部	哈尔滨市道里区地段街190号	84644674
150020	哈尔滨 哈尔滨市道外区尼康映像数码维修站	哈尔滨市道外区南勋街18号	88940125
116021	大连 大连中服电子技术服务中心	大连市沙河口区西南路791号-7-3	86841988
130021	长春 长春市朝阳区圣炎夏普维修站	长春市工农大路28号(桂林路与富锦路交汇)	85625783
130000	长春 关南区鑫昌行声光科技商行	长春市南关区卫星路卫星嘉园13栋3单元205门市	85399851
710014	西安 陕西百利商贸有限公司	西安市丰禾路6号丰禾小区22号楼2楼	86220211
南区			
510600	广州 广州市博健电器有限公司	广州市五羊新城明月二路春风路E-12栋首层	87386165(6)
518028	深圳 深圳市顺电连锁股份有限公司	深圳市华强北路上步工业区202栋2楼东	83286255
400020	重庆 重庆市渝中区中侨家用电器维修部	重庆市江北区建新南路18号城市领地A栋附楼2楼7号门市	63527117
530001	南宁 南宁市南方家电维修中心	广西南宁市唐山路29号首层	3118895/3907787
650051	昆明 昆明松和电器有限公司	昆明市环城北路280号	3645557
430015	武汉 武汉市江岸区兆利达家电维修中心	汉口解放大道1439号4栋3单元101室	85790611
410007	长沙 长沙市俊铭电器有限公司	长沙市车站南路93A-940号	4148005
610017	成都 成都市武侯区金维电子经营部	成都市大安东路57号3-6号	66656887
528200	佛山 佛山市禅城区得盛家电维修部	佛山市城西西商业街10号	83213535
350001	福州 福州福春电器维修服务有限公司	福州市塔头路328号顺意园一楼店面(福州锅炉厂对面)	87582122
325000	温州 温州市声像技术服务公司	温州市锦绣路利苑花苑5幢一层南1-05号	88850706/10187

上海涵思贸易有限公司可办理零件及产品邮购 电话: (021)64606449

E-mail: sp-order@hansi.sh.cn 邮编: 201100

注: 如果当地无特约维修站, 请与就近的维修站联系。

固话免费咨询热线: 800-820-1357 手机用户咨询热线: 400-820-1357



博朗(上海)国际贸易有限公司

地址: 上海市外高桥保税区菲拉路55号综合楼第四层A部位

售后服务日常联系地址: 中国上海浦东三林路550号 邮编: 200124

上述售后服务部地址确定于2009年11月, 可能有不定期更新。如有疑问, 请咨询客户服务热线。

固话免费咨询热线: 800-820-1357 手机用户咨询热线: 400-820-1357

English

Our products are designed to meet the highest standards of quality, functionality and design. We hope you enjoy your new Braun Shaver.

Please read the use instruction carefully and thoroughly before using the appliance.

Warning

Your shaving system is provided with a special cord set, which has an integrated Safety Extra Low Voltage power supply. Do not exchange or tamper with any part of it, otherwise there is risk of an electric shock. This appliance is not intended for use by children or persons with reduced physical or mental capabilities, unless they are given supervision by a person responsible for their safety. In general, we recommend that you keep the appliance out of reach of children. Children should be supervised to ensure that they do not play with the appliance.

Description

- 1 Foil & Cutter cassette
- 2 Long hair trimmer
- 3 Precision setting switch («lock»)
(390cc only)
- 4 On/off switch
- 5 Charging lights (green)
- 6 Low-charge light (red)
- 7 Cleaning light (yellow)
- 8 Replacement light for shaving parts
(390cc only)
- 9 Shaver power socket
- 10 Special cord set
- 11 Travel pouch (390cc only)
- 12 Foil protection cap (350cc only)

Charging

The best environmental temperature for charging is between 15 °C to 35 °C. Do not expose the shaver to temperatures higher than 50 °C for extended periods of time.

- Using the special cord set (10), connect the shaver to an electrical outlet with the motor switched off.

- When charging for the first time, leave the shaver to charge continuously for 4 hours. Subsequent charges will take about 1 hour.
- A full charge provides up to 45 minutes of cordless shaving time depending on your beard growth.
- Shave without the cord. With normal use the shaver will be charged automatically after every cleaning in the Clean&Renew™ (see «C Clean&Renew™»).
- Maximum battery capacity will only be reached after several charging/discharging cycles.
- 5-minute quick charge (with the special cord set (10)) is sufficient for a shave.
- If the rechargeable batteries are discharged, you may also shave by connecting the shaver to an electrical outlet via the special cord set.

Charging lights (5)

The green charging lights show the charge status of the batteries. The green charging light blinks when the shaver is being charged or switched on. When the battery is fully charged, all green charging lights shine permanently, provided the shaver is switched on or connected to an electrical outlet.

Low-charge light (6)

The red low-charge light flashes when the battery is running low. You should be able to finish your shave.

A Shaving

Press the on/off switch (4) to operate the shaver (picture).

The flexible shaving foils automatically adjust to every contour of your face (picture).

Long hair trimmer (2)

To trim sideburns, moustache or beard, slide the long hair trimmer upwards.

Precision setting switch («lock») (3) (390cc only)

For precise handling in hard to shave areas (e.g. under the nose) slide the switch (3) to the right to position «lock». The centre trimmer and one foil will be lowered.

Tips for the perfect shave

For best results, Braun recommends you follow 3 simple steps:

1. Always shave before washing your face.
2. At all times, hold the shaver at right angles (90°) to your skin.
3. Stretch your skin and shave against the direction of your beard growth.

B Keeping your shaver in top shape

Cleaning indicator

Your shaver should be cleaned daily in the Clean&Renew™, and certainly when the yellow cleaning light (7) shines constantly after shaving. If this is not done, the yellow light will go out after some time. The shaver's electronics will then assume it has been cleaned manually and a new calculation of the time when the next cleaning is required will be started. During the cleaning process in the Clean&Renew™ the yellow light will flash and will go off after approx. 4 hours when cleaning is finished.

Automatic cleaning

Once the shaver is put into the Clean&Renew™, it is cleaned automatically (see «C Clean&Renew™»).

Manual cleaning is recommended only when the Clean&Renew™ is not available, e. g. when travelling.

Manual cleaning



The shaver head is suitable for cleaning under running tap water.

Warning: Detach the shaver from the power supply before cleaning the shaver head in water.

Regular cleaning ensures better shaving performance. Rinsing the shaver head under running water after each shave is an easy and fast way to keep it clean:

- Switch the shaver on (cordless) and rinse the shaver head under hot running water. You may use liquid soap without abrasive

substances. Rinse off all foam and let the shaver run for a few more seconds.

- Next, switch off the shaver, remove the shaver Foil & Cutter cassette (1) and let it dry.
- If you regularly clean the shaver under water, then once a week apply a drop of light machine oil onto the long hair trimmer (2) and shaver Foil & Cutter cassette (1).

Alternatively, you may clean the shaver using a brush:

- Switch off the shaver. Remove the shaver Foil & Cutter cassette and tap it out on a flat surface.
- Using a brush, clean the inner area of the shaver head. However, do not clean the shaver Foil & Cutter cassette with a brush as this may damage it.

Replacement light for shaving parts/Reset (390cc only)

To maintain 100% shaving performance, replace the shaver Foil & Cutter cassette (1), when the replacement light for shaving parts (8) comes on (after about 18 months) or when worn.

The replacement light will remind you during the next 7 shaves to replace the foil and cutter cassette. Then the shaver will automatically reset.

After you have replaced the Foil & Cutter cassette (1), press the on/off switch (4) for at least 5 seconds to reset the counter. While doing so, the replacement light blinks and goes off when the reset is complete. The manual reset can be done at any time.

Model 350cc: To maintain 100% shaving performance, replace the shaver Foil & Cutter cassette (1), at least every 18 months or when worn.

Preserving the batteries

In order to maintain the optimum capacity of the rechargeable batteries, the shaver has to be fully discharged (by shaving) every 6 months approximately. Then recharge the shaver to full capacity.

Environmental notice

This product contains rechargeable batteries. In the interest of protecting the environment, please do not dispose of the product in the household waste at the end of its useful life. Disposal can take place at a Braun Service Centre or at appropriate collection sites provided in your country.



C Clean&Renew™

Braun Clean&Renew™ has been developed for cleaning, charging and storing your shaver. Clean your shaver daily in the Clean&Renew™. During the automated cleaning process, the shaver is switched on and off at intervals to obtain best cleaning results. Since the specially formulated cleaning fluid contains a small amount of oil, the cleaning procedure also fulfils the lubrication needs of the shaver.

Important

- Only use the power supply cord set supplied with the shaver.
- In order to avoid any leakage of the cleaning fluid, place the appliance on a flat, stable surface. Do not tip, move suddenly or transport in any way if a cleaning cartridge is installed.
- Do not place the appliance in a mirror cabinet, nor store it over radiators, nor place it on polished or lacquered surfaces. Do not expose to direct sunlight.
- The appliance contains highly flammable liquid. Keep it away from sources of ignition. No smoking.
- Keep out of reach of children. Do not refill cartridge. Use only original Braun refill cartridge.

Description

- 1 Start/release button
- 2 Contact bow
- 3 Lift button for cartridge exchange
- 4 Level indicator
- 5 Cleaning cartridge

Before using Clean&Renew™

Installing the cartridge

- Press the lift button (3) to open the housing.
- Hold the cartridge down on a flat, stable surface (e.g. table). Carefully remove the lid from the cartridge. Slide the cartridge into the base as far as it will go.
- Slowly close the housing by pushing it down until it locks.

Replacing the cartridge

After having pressed the lift button to open the housing, wait for a few seconds before removing the used cartridge.

Before discarding the used cartridge, make sure to close the openings using the lid of the new cartridge, since the used cartridge will contain contaminated cleaning solution. The used cartridge can be disposed in the household waste.

Operating your Clean&Renew™

- Connect your Clean&Renew™ with the cord set to the mains electricity supply. The special socket at the back is adjustable to save space. After each shave, switch the shaver off and put it into the Clean&Renew™, upside down and with the front showing.
- Push the start/release button (1) to lock and connect the shaver. The cleaning process will start. The yellow light on the shaver will flash during the complete process (approx. 2 minutes cleaning, min. 4 hours drying).
- Do not interrupt the cleaning process, as it leaves the shaver wet and not fit for use. If interruption is needed nonetheless, press the start/release button (1).
- When cleaning is finished, the yellow light will go off and the shaver is ready for use. To release it, push the start/release button.
- A cleaning cartridge should be sufficient for about 30 cleaning cycles. When the level indicator (4) has reached the «min» mark, the remaining fluid in the cartridge is

sufficient for about 5 more cleaning cycles. Then the cartridge should be replaced, when used daily approx. every 4 weeks.

- The hygienic cleaning solution cartridge contains alcohol which, once opened, will naturally evaporate slowly into the surrounding air. Each cartridge, if not used daily should be replaced after approx. 8 weeks.
- The cleaning cartridge also contains lubricates, which may leave residual marks on the shaver head after cleaning. However, these marks can be removed easily by wiping gently with a cloth or soft tissue paper.
- Clean the housing from time to time with a damp cloth, especially the opening where the shaver rests.

Accessories

Available at your dealer or Braun Service Centres:

- **Foil & Cutter cassette:** 32S/32B
- **Cleaning cartridge Clean&Renew™:** CCR

Subject to change without notice.

This product conforms to the European Directives EMC 2004/108/EC and Low Voltage 2006/95/EC. 

For electric specifications, see printing on the special cord set.

Please do not dispose of the product in the household waste at the end of its useful life. Disposal can take place at a Braun Service Centre or at appropriate collection points provided in your country.

